

## Applications

- Absorption / transmission / reflection measurement systems.
- Operable as an excitation light source in fluorescence measurement systems
- Eye protection products measurement system
- PEC photochemistry measurement systems
- Solar cell quantum efficiency measurement systems

## Features

- Monochromatic light from 250 nm up to 2500 nm
- Collimated, condensed, or coupled output light options. Light can be coupled to any optical system (including fibers and fiber bundles)
- Adjustable optical resolution from 48 nm down to 0.2 nm
- Flexibility of optional features: full automation, various sources and monochromators and more.
- Computer-controlled.

# TUNABLE LIGHT SOURCES TLS-Series



# Tunable Light Sources

## OVERVIEW

Sciencetech offers a series of computer-controlled adjustable sources of monochromatic light, our Tunable Light Source (TLS) line. Each TLS system is pre-aligned at the Sciencetech test lab and packaged with the system's test data and detailed manual. Sciencetech's tunable light sources are motorized instruments controlled by Sciencetech's Windows based software. LabView drivers, ActiveX and DotNet modules are also available making the TLS a flexible system for integration with your experiment or instrument.

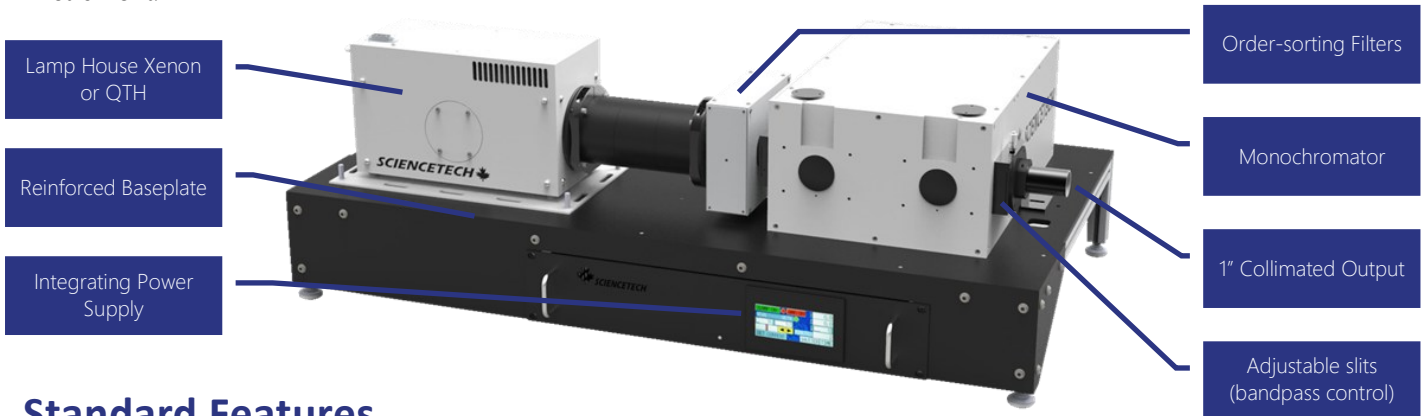

### Standard Features

Each base model comes with standard features:

- Sciencetech light source, Xe or QTH.
- 1" optics are used to collimate light output<sup>1</sup>
- Sciencetech monochromator, three-grating turret with two gratings included.
- Adjustable slits for optical bandpass control.
- Motorized filter wheel with 4 long pass filters installed.
- Adjustable computer-controlled power supply.
- SciSpec software for controlling the monochromator and filter wheel.
- Reinforced optical base plate.

### Output Options

Sciencetech TLS Systems come standard with 1" collimating optics. A variety of alternative optics are available to suit different irradiance, uniformity, collimation, and beam shape requirements.

Output Optics	Divergence	Uniformity	Irradiance	Beam Shape
Collimated Beam TLS-XX-QT250	Collimated	Mid	Mid	
Collimated Beam TLS-XX-XE300	Collimated	Poor	Mid	
Homogenized Beam	Divergent	Good	Mid	
Focused Beam	Divergent	Poor	High	

1: The collimated beam shape can change depending on monochromator geometry and selected wavelength. To produce consistent beam shape and size at all wavelengths, the addition of a beam homogenizer is recommended.

# Tunable Light Sources

## SPECIFICATIONS

Sciencetech's software, Sci-Spec, controls all components of the system. In the standard configuration, it controls the power supply of the light source, shutter, filter wheel, and monochromator. As an option, the user can add computer control on the input and output slits, and/or control of the iris. In the standard configuration, the output beam can be collimated or focused. Coupling with different devices is available as an option, such as coupling with a sample chamber, fiber, or fiber bundle.

### Customized Solutions

Sciencetech TLS systems are built with modular components making them flexible and adaptable well beyond the standard models offered.

All components of the system, including the light source and monochromator can be customized. Available options include:

- Xe, Xe-Hg and Hg lamps from 75-300 W
- QTH lamps 50-250 W
- Dual deuterium/QTH source
- Mid-IR sources up to 1700 Kelvin
- Available spectral range 180 nm – 10 um (Light source, optics and grating dependent)
- Double subtractive and double additive monochromators
- Monochromators up to 1.5 meter focal length
- Motorized or manual iris
- Optical light feedback for additional source stabilization (only available with Xe lamps)
- Detectors and data acquisition systems can be provided as add-ons
- Can be coupled with Integrating Spheres, samples chambers and other opto-mechanical components upon request

MODELS	TLS-72-XE300	TLS-72-QT250	TLS-55-XE300	TLS-55-QT250
Lamp Type	Xe 300 W	QTH 250 W	Xe 300 W	QTH 250 W
Monochromator Type	9072S (1/8 meter)		9055 (1/4 meter)	
Functional Spectral Range	250-2500 nm			
Optical resolution	0.5 nm @ 250-450 nm		0.2 nm @ 250-450 nm	
	1 nm @ 450-2500 nm		0.4 nm @ 450-2500 nm	
Filter wheel with filter set	Computer-controlled 6-position filter wheel			
Shutter	Optional computer-controlled shutter and exposure control			
Beam output	Collimated with 25 mm [1"] diameter optics <sup>1</sup>			
Wavelength Repeatability	0.1 nm			
Wavelength Accuracy	0.3 nm		0.2 nm	
Intensity Control	Source intensity adjustable.   Optional manual iris			
Gratings	2 plane ruled gratings (30 × 30 mm):		2 plane ruled gratings (50 × 50 mm):	
	1200 l/mm @ 300 nm		1200 l/mm @ 300 nm	
	600 l/mm @ 1000 nm		600 l/mm @ 1000 nm	
Bandpass	Two manual bilaterally-adjustable slits with vertical curtain attenuators			
Optical Height	215 mm [8.5"], adjustable +/- 5 mm			
Power supply	PS-XE300-A-T	PS-QT250-A-T	PS-XE300-A-T	PS-QT250-A-T
Software	Sci-Spec (Labview examples, DotNet, Active X also available)			
Computer Interface	USB—monochromator and filter wheel, RS232 Power Supply			
Dimensions (mm)	822 × 418 × 332		921 × 545 × 332	
Weight	30 kg		37 kg	
CE Certification	IEC 61010-1:2010 Safety Requirements for electrical equipment for measurement, control and laboratory use—Part 1			
	IEC 61326-1:2012 Electrical equipment for measurement, control and laboratory use—EMC requirements—Part 1			

1: The collimated beam shape can change depending on monochromator geometry and selected wavelength. To produce consistent beam shape and size at all wavelengths, the addition of a beam homogenizer is recommended.

# Tunable Light Sources

# POWER SUPPLY

## Touchscreen Power Supply - PS-XE-300-A-T or PS-QT250-A-T

Standard features included with Sciencetech’s touchscreen power supplies:

- Touchscreen interface
- Shutter and exposure control (if electronic shutter is supplied)
- Single connection for lamp power, cooling, and communication
- Lamp starts and timer log
- Fan cooling safety interlock



(Above) Model PS-XE300-A-T touchscreen power supply

### Sci-Spec Software Included

SciSpec is a computer-controlled software platform designed to coordinate the operation of Sciencetech’s modular spectroscopy components. It is fully functional and compatible with a wide range of electronic devices. The software supports control of the following components:

- Motorized filter wheels for long pass, bandpass, short pass, or neutral density filtering
- Motorized beam path selection mirrors
- Beamline modulators such as motorized irises or choppers
- Data acquisition components including A/D boards, lock-in amplifiers, and source meters, linear diode arrays



(Above) Touchscreen power supply main control screen

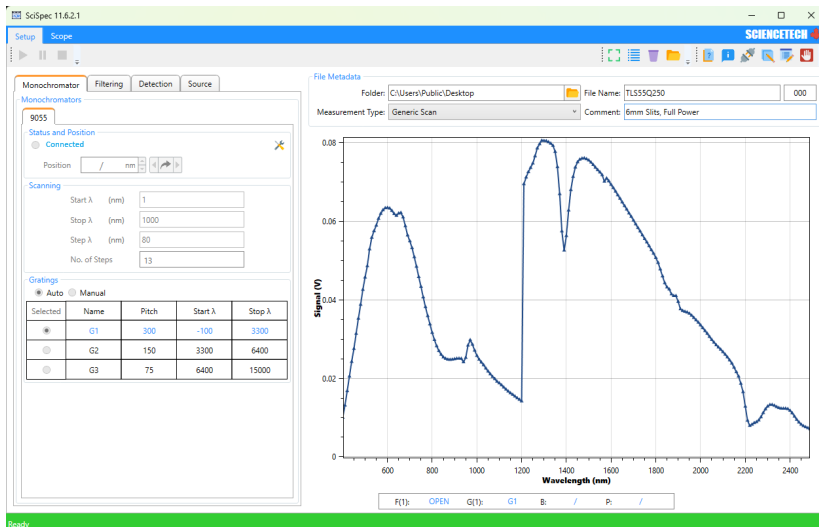

Sci-Spec Software

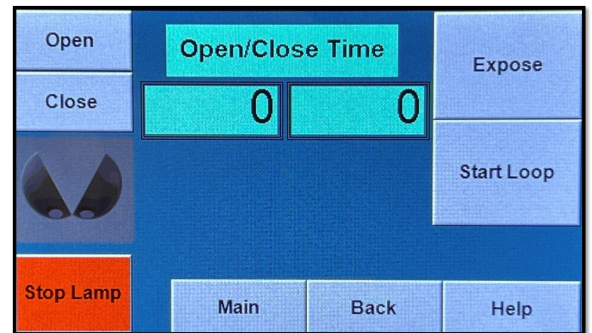

(Above) Touchscreen power supply automatic shutter control screen

# Tunable Light Sources

## SPECTRAL POWER DISTRIBUTION

TLS-55-QT250 Spectral Power Distribution for a Given Bandpass

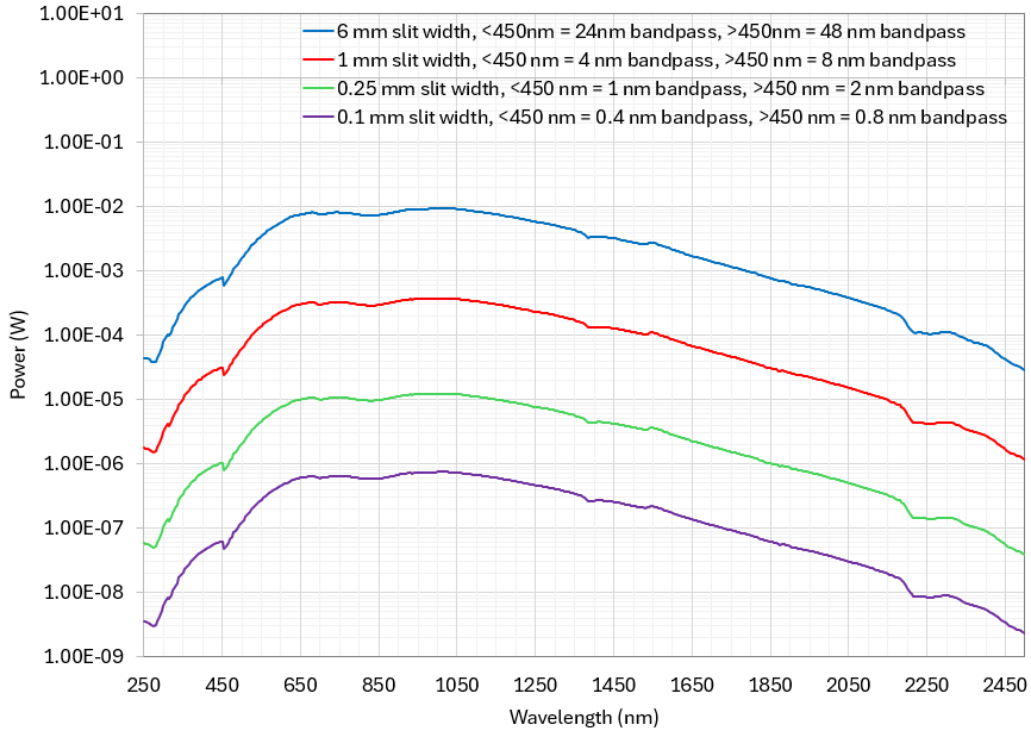

TLS-55-XE300 Spectral Power Distribution for a Given Bandpass

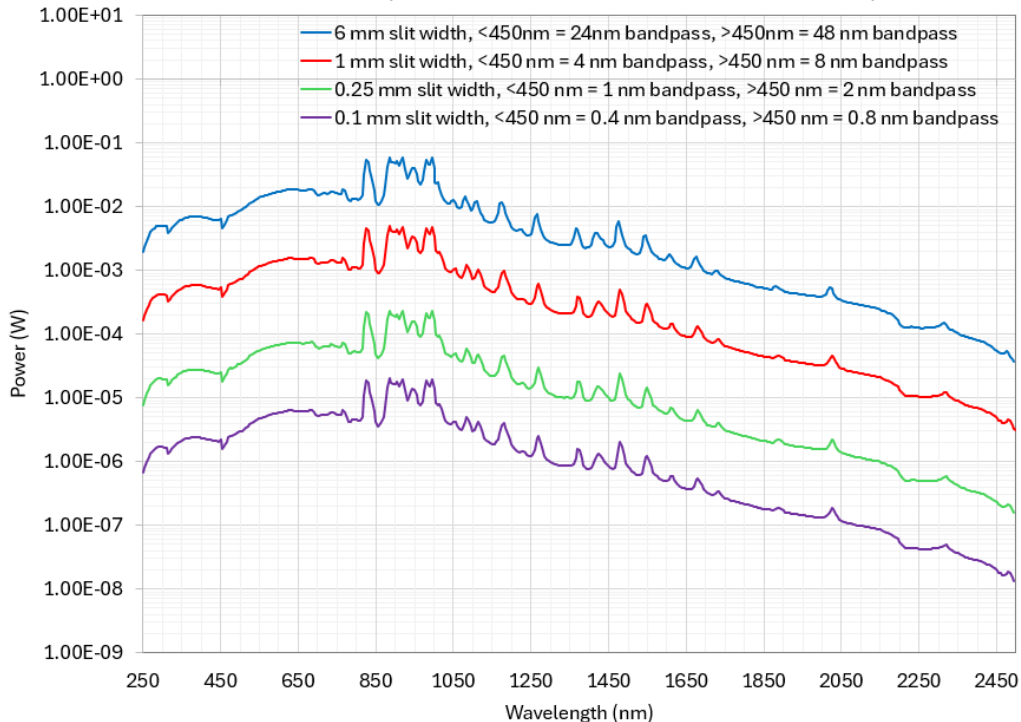

The QTH lamp provides a smoother spectral power distribution and superior temporal instability, making it ideal for consistent spectral output. The Xe lamp provides broad spectral coverage with high-intensity UV and visible emission, suitable for applications requiring strong UV-VIS output.

# Tunable Light Sources

## TLS SOLAR SIMULATOR

### TLS-55-XE300-SS



Have a solar simulator and tunable light source in one!

- The TLS-55-XE300-SS combines the flexibility of a tunable light source with the features of a solar simulator. A mirror in place of one grating position allows broadband light to pass through the system, where it is further refined by an air mass filter.

The homogenized output provides a uniform target for the solar light with Class B non-uniformity. This uniform area can also be used in monochromatic mode, yielding a homogenous monochromatic spot.

TLS-55-XE300-SS Specifications

Solar Simulator Mode		General	
Lamp Type	Xe 300 W	Target Area (diameter, mm)	25.4
Monochromator Type	9055 (1/4 meter)	Air Mass	AM1.5G
Functional Spectral Range	250-2500 nm for TLS	Spectral Match <sup>1</sup>	Class A
Optical resolution	0.2 nm @ 250-450 nm 0.4 nm @ 450-2500 nm	Spatial Non-Uniformity <sup>1</sup>	Class B
Filter wheel with filter set	Computer-controlled 6-position filter wheel	Temporal Instability	Class A
Wavelength Repeatability	0.1 nm	Working Distance (mm)	240
Wavelength Accuracy	0.2 nm	Test Plane Depth (mm)	4
Shutter	Optional computer-controlled shutter and exposure control	Power Supply	PS-XE300-A-T
Beam output	Collimated with 25 mm [1"] diameter optics <sup>1</sup>	Software	Sci-Spec (Labview examples, DotNet, Active X also available)
Intensity Control	Source intensity adjustable.   Optional manual iris	Computer Interface	USB—monochromator and filter wheel, RS232 Power Supply
Gratings	2 plane ruled gratings (50 × 50 mm): <ul style="list-style-type: none"> <li>• 1200 l/mm @ 300 nm</li> <li>• 600 l/mm @ 1000 nm</li> </ul> Third grating position occupied by mirror.	Dimensions (mm)	921 × 545 × 332
Bandpass	Two manual bilaterally-adjustable slits with vertical curtain attenuators	Weight	37 kg
Optical Height	215 mm [8.5"], adjustable +/- 5 mm	CE Certification CE Certification	IEC 61010-1:2010 Safety Requirements for electrical equipment for measurement, control and laboratory use—Part 1 IEC 61326-1:2012 Electrical equipment for measurement, control and laboratory use—EMC requirements—Part 1

<sup>1</sup> Evaluated to ASTM E927-19 standards.

# Tunable Light Sources

# TLS SOLAR SIMULATOR

## Spectral Match - Class A

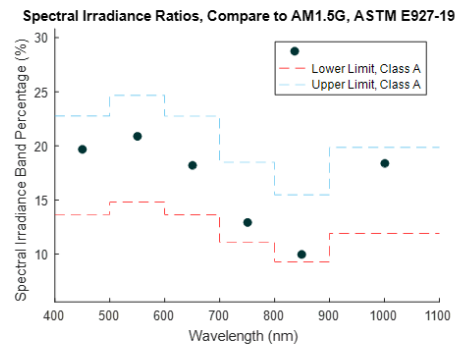
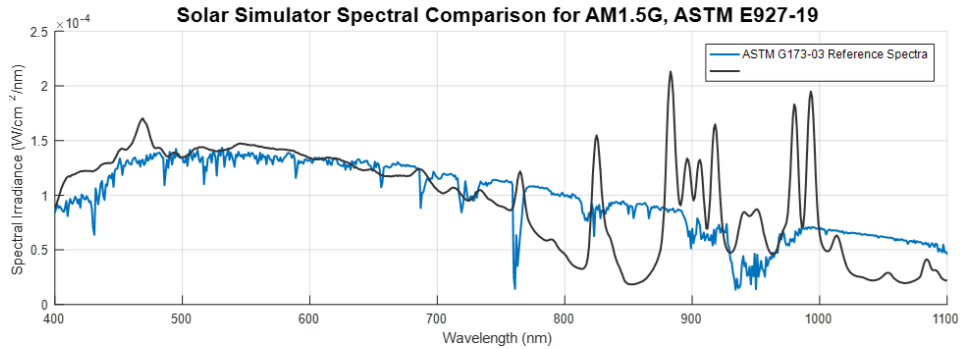

Wavelength	Percentage	Class
'400-500'	'19.6549'	'A'
'500-600'	'20.8746'	'A'
'600-700'	'18.207'	'A'
'700-800'	'12.9011'	'A'
'800-900'	'10.0083'	'A'
'900-1100'	'18.3541'	'A'

## Spatial Non-Uniformity - Class B

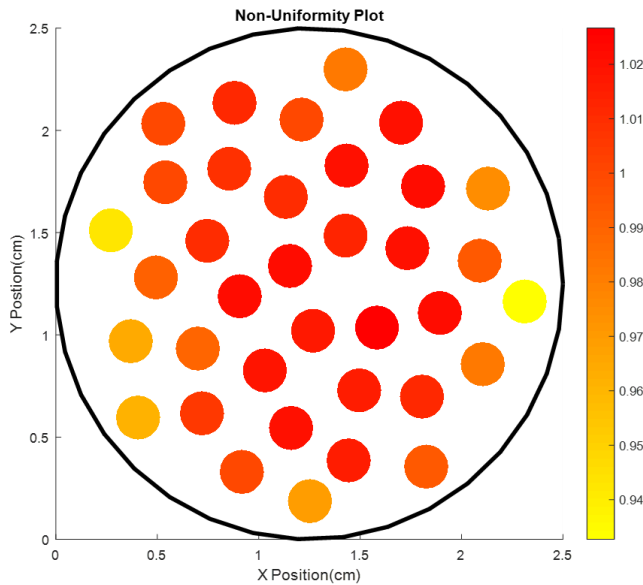

## Temporal Instability - Class A

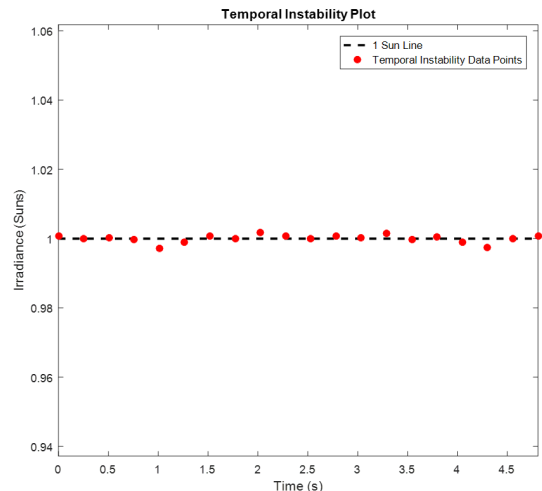

# Tunable Light Sources

## OPTIONAL UPGRADES

Various output accessories can be fitted to the monochromator input/output to customize the system for different applications either as a stand-alone unit or to be used in conjunction with other optical devices and systems. Browse the below options to see if any other upgrades and accessories might be required for your application.

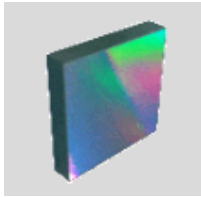

### Gratings

---

Choose the most suitable gratings to be used with your TLS to optimize light output according to your wavelengths of interest.

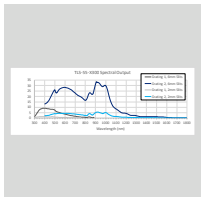

### TLS Spectral Power Calibration (810-0010)

---

This service provides optical power measurement from 300 to 1800 nm, as well as output beam dimensional measurement.



### Motorized Slit(s) (120-9053)

---

The SS-80 is a motorized adjustable slit for the input or output port of a Sciencetech monochromator.



### Fiber Optic Light Cables

---

Various fiber optic cables and light guides can be coupled to input or output slits of the tunable light source.

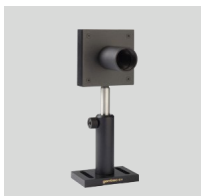

### Detectors (Single or Multi Channel)

---

Allows the measurement of light at output slits of the system.

# Tunable Light Sources

## OPTIONAL UPGRADES

Various output accessories can be fitted to the monochromator input/output to customize the system for different applications either as a stand-alone unit or to be used in conjunction with other optical devices and systems. Browse the below options to see if any other upgrades and accessories might be required for your application.

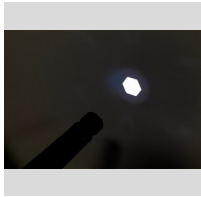

### Homogenizing light pipe

---

Homogenizing light pipes can be coupled to the output slit of the TLS to provide a highly spatially uniform light output on the target.

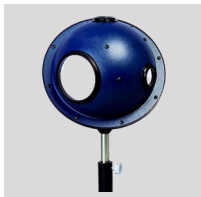

### Integrating Spheres

---

Integrating spheres can be coupled to output slits of the TLS.



### Dual input/output slit upgrades

---

Allow the use of second input/output ports with the use of switching mirrors. Only applicable for TLS models with 9055 monochromators.



### Beam splitter

---

Beam splitters can be installed to split the input or output beams to direct to various detectors and other optomechanical instruments.



### Light Intensity Stabilizer

---

The LIS is an upgrade for the touchscreen power supply and the associated lamp house.

# Tunable Light Sources

# DIMENSIONS

Dimensions are in [mm] and inches.

## TLS-55-XE300

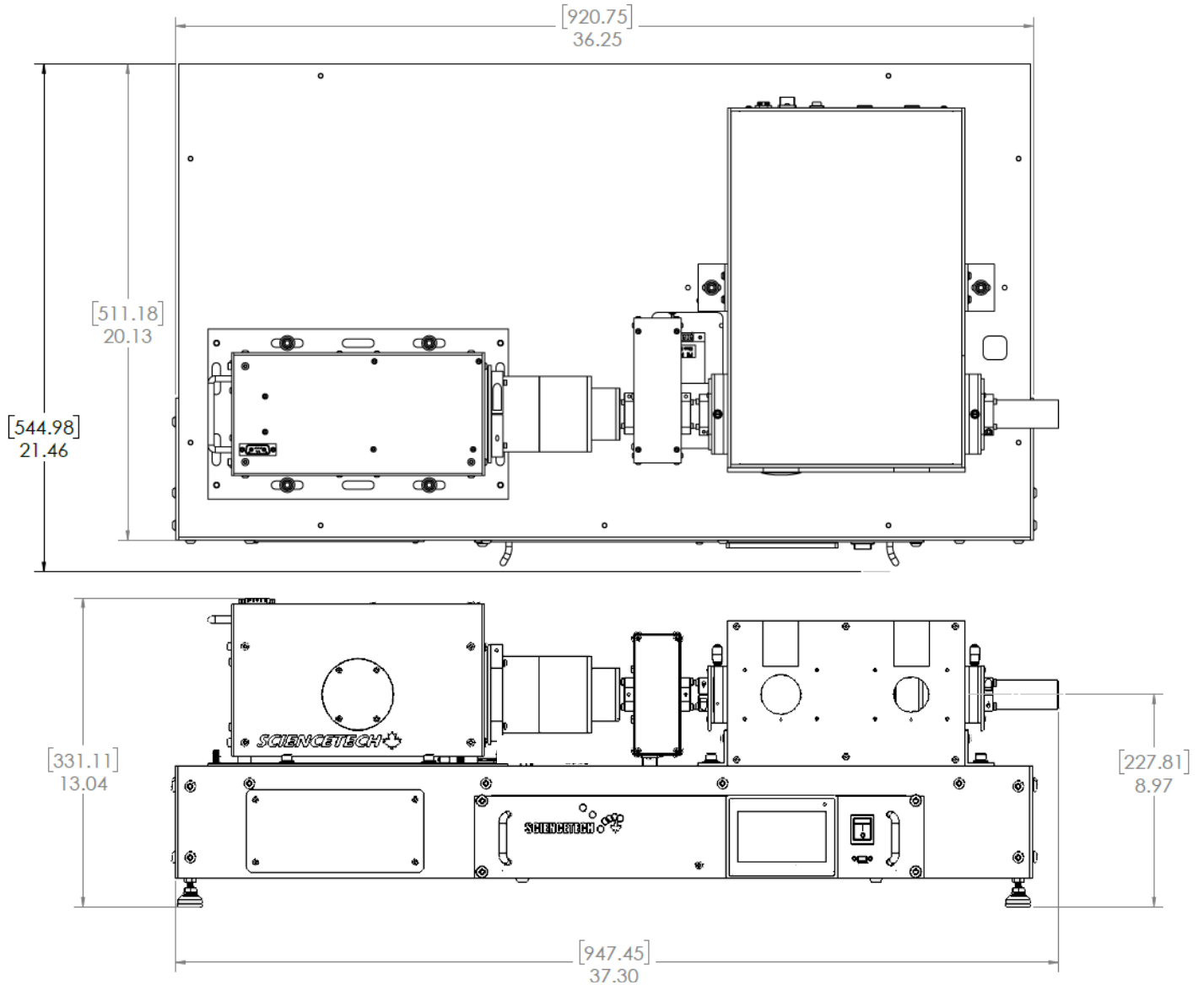

NOTE: KEEP ALL AIR VENTS CLEAR 6" (152 mm)

# Tunable Light Sources

# DIMENSIONS

Dimensions are in [mm] and inches.

## TLS-55-QT250

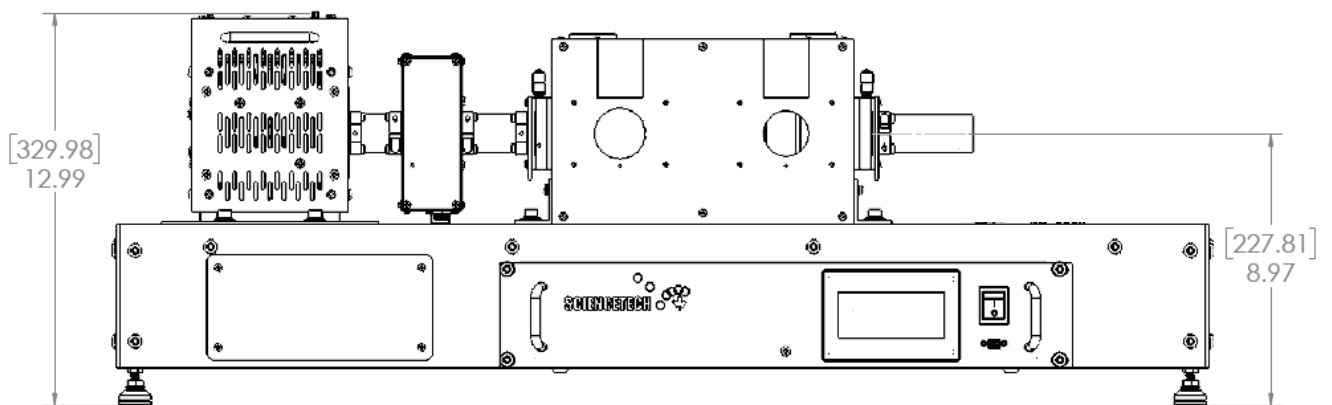
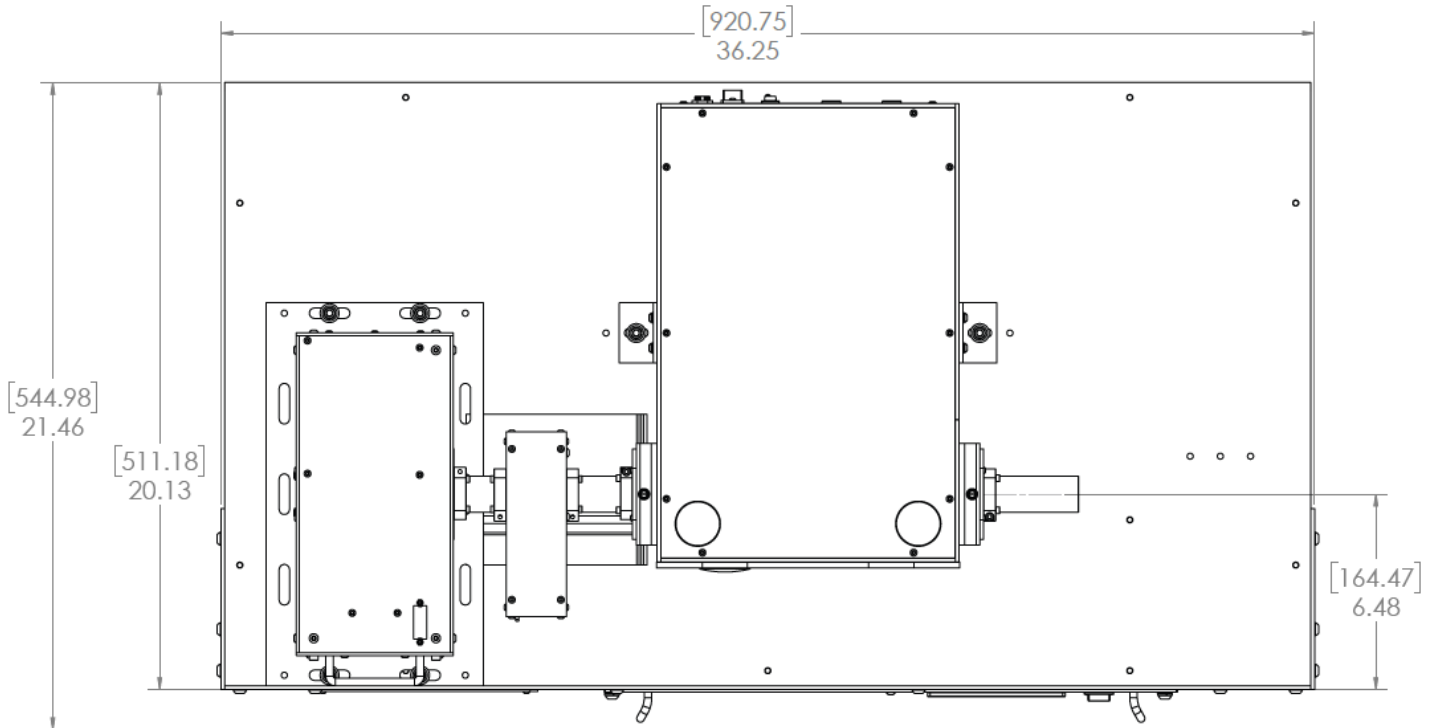

NOTE: KEEP ALL AIR VENTS CLEAR 6" (152 mm)

# Tunable Light Sources

# DIMENSIONS

Dimensions are in [mm] and inches.

## TLS-72-XE300

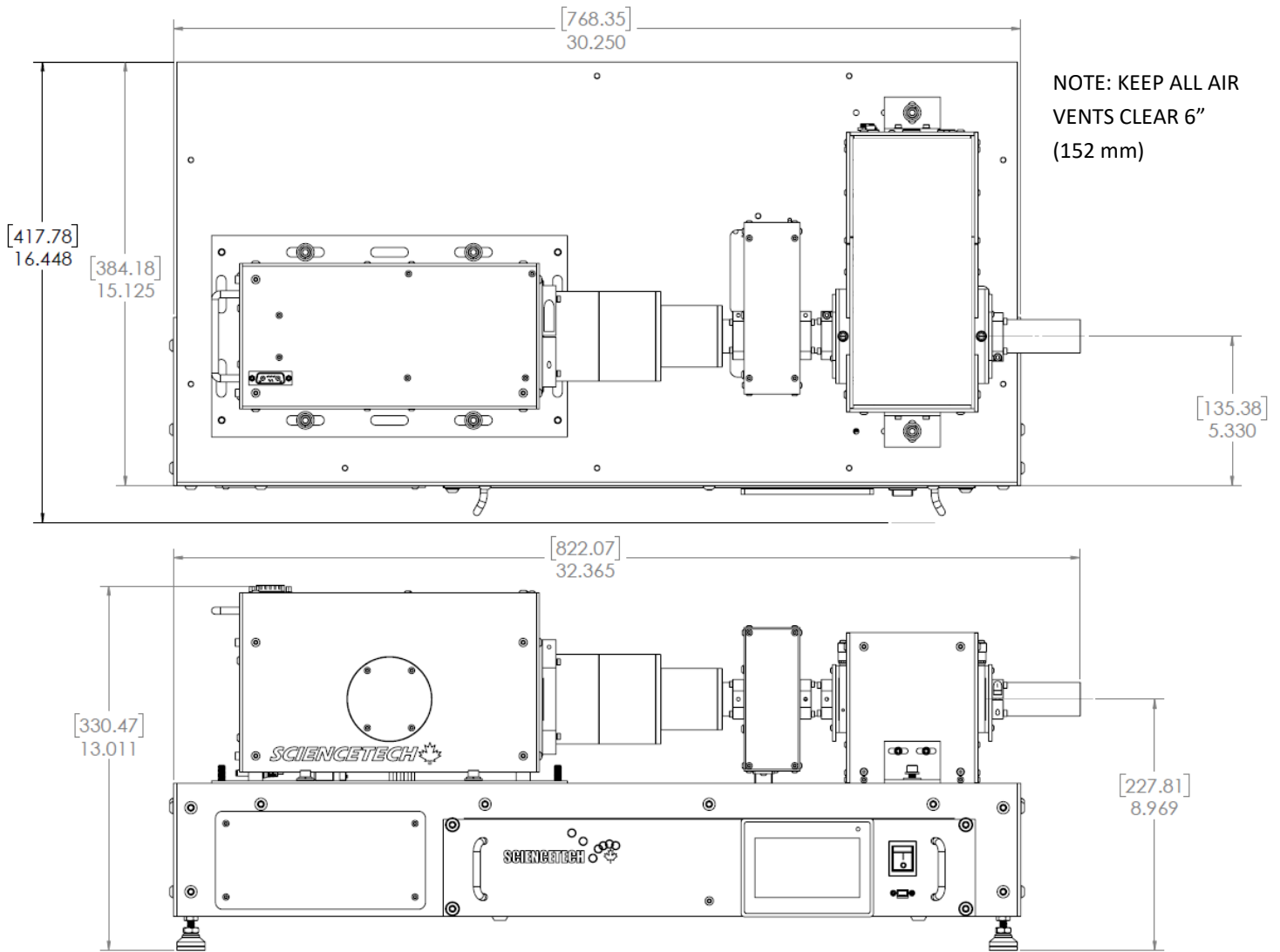

# Tunable Light Sources

## DIMENSIONS

Dimensions are in [mm] inches.

### TLS-72-QT250

NOTE: KEEP ALL AIR VENTS  
CLEAR 6" (152 mm)

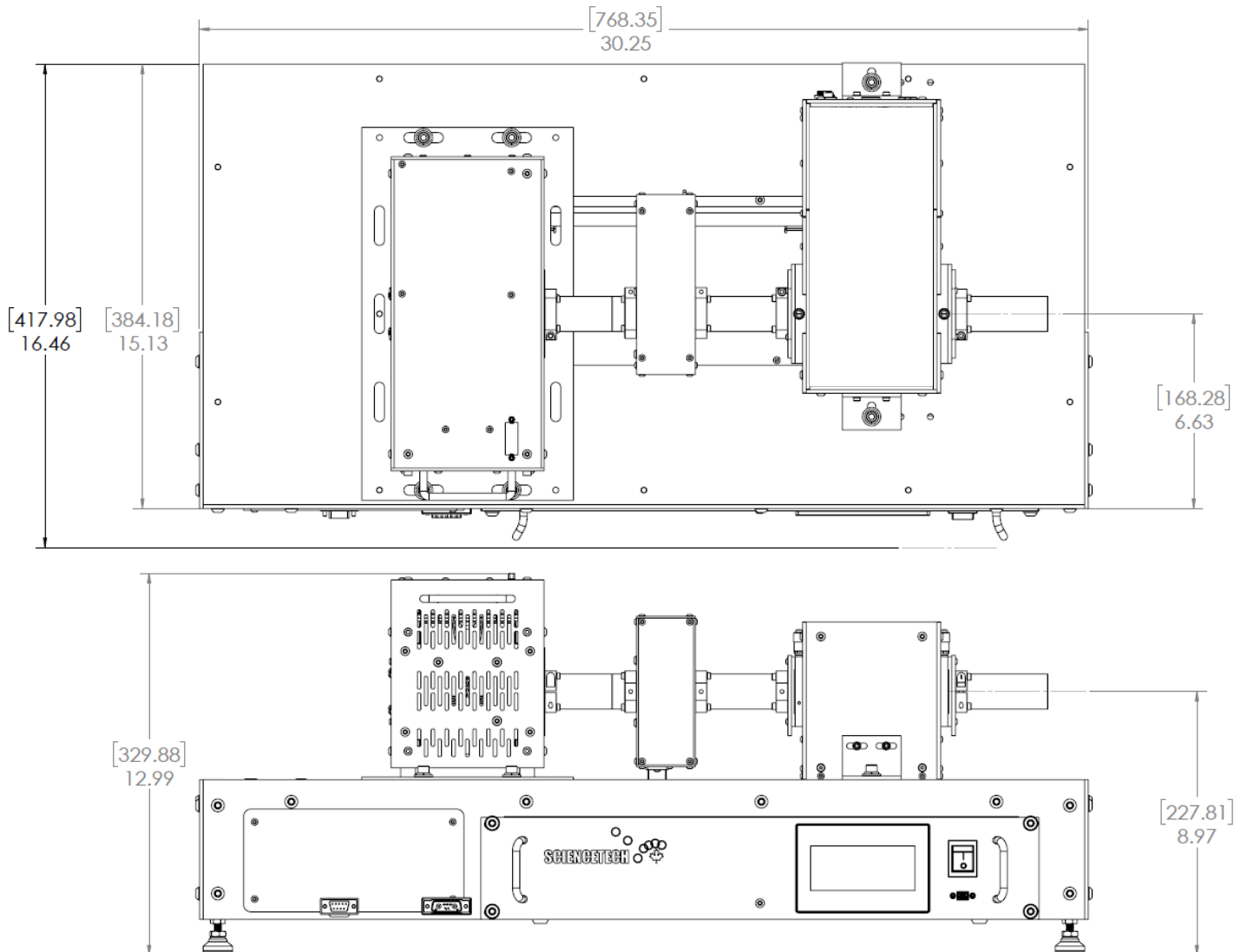

# Tunable Light Sources

## DIMENSIONS

Dimensions are in [mm] inches.

### TLS-55-XE300-SS

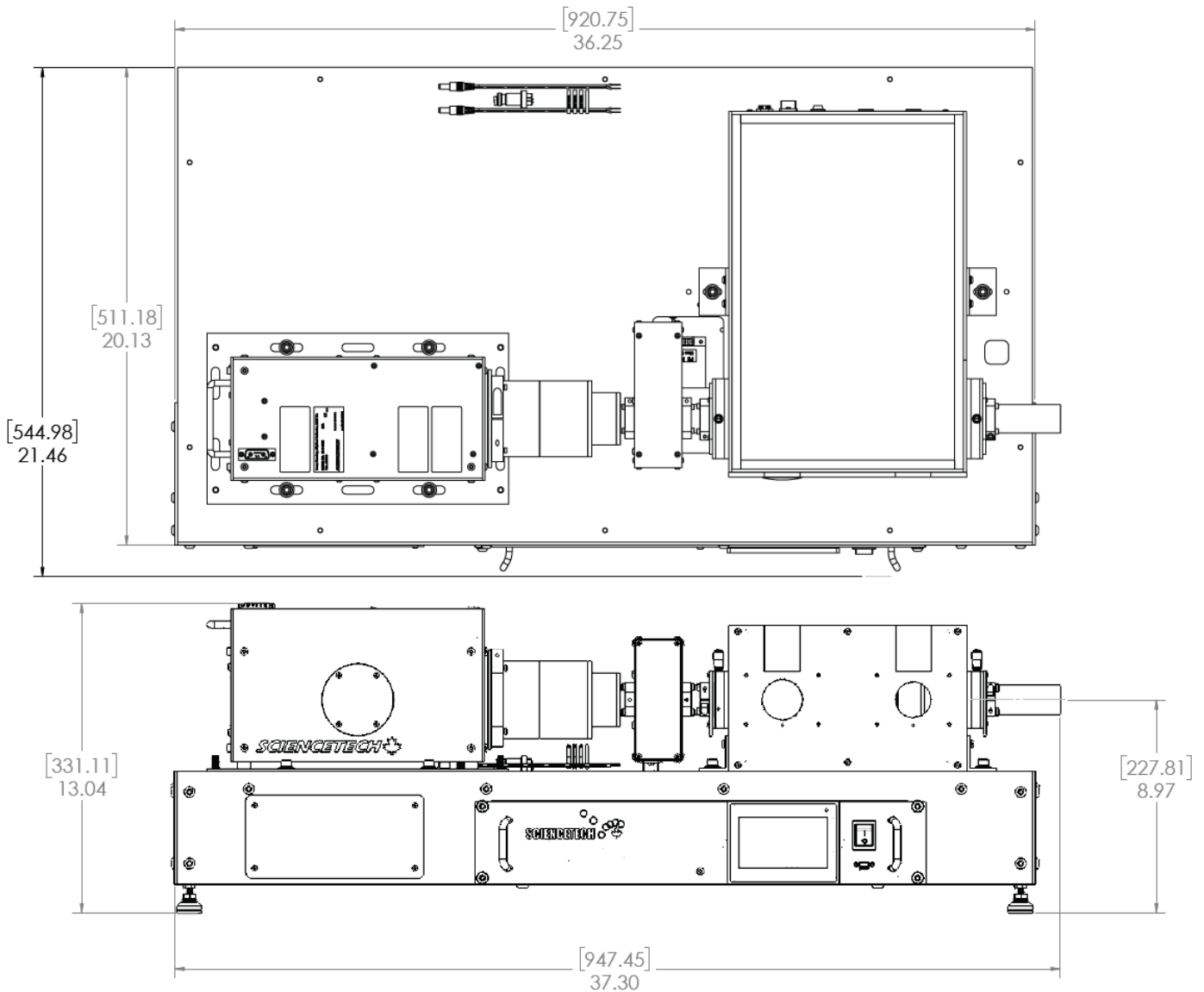

NOTE: KEEP ALL AIR VENTS  
CLEAR 6" (152 mm)

# Tunable Light Sources

## ORDERING INFORMATION

Reference Number	Model Name	Description
105-9001	TLS-72-XE300	Tunable Light Source, 1/8 m Focal Length Monochromator, 300 W Xenon Light Source
105-9003	TLS-72-QT250	Tunable Light Source, 1/8 m Focal Length Monochromator, 250 W QTH Light Source
105-9002	TLS-55-XE300	Tunable Light Source, 1/4 m Focal Length Monochromator, 300 W Xenon Light Source
105-9004	TLS-55-QT250	Tunable Light Source, 1/4 m Focal Length Monochromator, 250 W QTH Light Source
105-9010	TLS-55-XE300-SS	Tunable Light Source and Solar Simulator
810-0010	TLS-CAL-PACKAGE	Calibration Package for Tunable Light Sources
110-8001	HOM1-120-5	Homogenizing light pipe for 25 mm (1") outputs, 5 mm x 120 mm light pipe
110-8002	HOM1-125-10	Homogenizing light pipe for 25 mm (1") outputs, 10 mm x 125 mm light pipe
110-8003	HOM1-175-10	Homogenizing light pipe for 25 mm (1") outputs, 10 mm x 175 mm light pipe
115-9033-C13	LIS-TL	Light Intensity Stabilizer
120-9053	SS-80-M	Bilaterally Adjustable Slit, Motorized
120-8030	DPIN-ST-MAN	Dual Input Ports with Flipping Mirror for 9055/35/57/60, Manual
120-8072	DPIN-ST-MOT	Dual Input Ports with Flipping Mirror for 9055/35/57/60, Motorized
120-8031	DPOUT-ST-MAN	Dual Output Ports with Flipping Mirror for 9055/35/57/60, Manual
120-8073	DPOUT-ST-MOT	Dual Output Ports with Flipping Mirror for 9055/35/57/60, Motorized
675-0001	4P-GPS-033	Integrating Sphere, 4 Port, 4 Inch, Spectralon Lined