

Applications

- Coatings Durability Testing
- Photobiology
- Photochemistry
- Spectroscopy
- Photocatalysis

Features

- Vertical or horizontal bulb and housing operation
- Xenon arc lamps from 75W to 300W
- Multiple collimated or focused output optics in various sizes, materials, and coatings
- User-friendly design
- Numerous available accessories
- Standard safety interlocks

**Research Grade Xenon
Arc Lamp Sources
Low/Med Power 75W - 300W**



Research Grade Xe Arc Lamp 75 - 300 W

OVERVIEW

Sciencetech offers a selection of arc lamp sources for research applications. Short arc lamps are high-pressure discharge lamps. These lamps are especially suitable for optical applications because of their high radiance and luminance. Light is generated by a discharge arc burning freely between two electrodes. The length of the arc is determined by the distance between the two electrodes, which is usually only a few millimeters. This makes arc lamps an ideal point source of light.

This brochure focuses on Sciencetech’s xenon arc lamp sources, with the lamp envelope filled with high-pressure xenon gas, providing a wide range of wavelengths of illumination.

Either select from one of our convenient packages from page 4 (which include optics, housing, bulb, and power supply, as well as all interconnections) or build your own from our modular components, allowing the perfect fit for your requirements. These lamp houses are designed to operate in a vertical or horizontal mode, and come with base plates for both orientations included. In the configuration section below, choose the housing based on the reflector type (spherical for collimated output, elliptical for focused beam) and desired arc lamp, and add the compatible power supply and lamp. Finally, add optics appropriate to your application. For some pre-configured packages, see the brochure.

Configuration-Housing

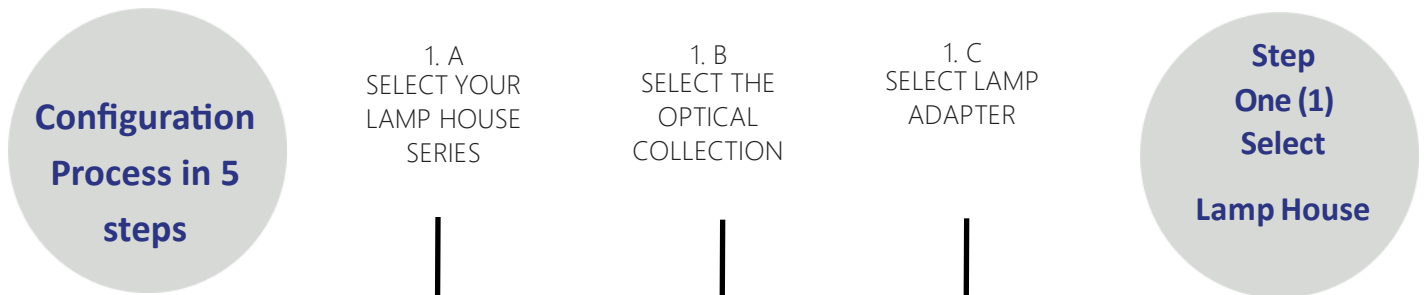

Selection Information

Bulb Wattage

Lamp House Series	Optical Collection	Lamp Type	Model
LH	-S	-300X	LH-S-300X
		-150X	LH-S-150X
		-100X	LH-S-100X
		-075X	LH-S-075X
	-E	-300X	LH-E-300X
		-150X	LH-E-150X
		-100X	LH-E-100X
		-075X	LH-E-075X

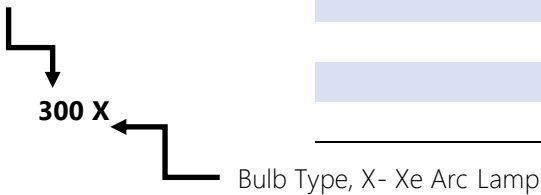

-S Spherical reflector and lens collection—standard in Sciencetech’s small series solar simulators!

-E Elliptical reflector collection, F/4.5—simple design, used with Sciencetech’s fiberized solar simulators!

Talk to one of Sciencetech’s technical representatives to help decide what is the best option for your application!



Research Grade Xe Arc Lamp 75 - 300 W

CONFIGURATION

2. Configuration—Output Optics

Step Two (2)

Select

Output Optics

A variety of optical coupling options are available with Sciencetech's line of collimating (COL) and imaging (IO) optics assemblies. The tables below provide information on the lens assembly configurations and the lens materials used. COL optics come mounted in a 75mm long lens tube. IO optics may come in lens tubes longer or shorter than 75mm depending on the configuration chosen.

COL—Collimating Line of Optical Assemblies					
Optic Family	Model	Aperture Ratio (F/#)	Standard Material	Spectral Range	Description
COL	-A	1.5	Fused Silica	230-2500nm	Single planoconvex spherical lens.
	-B	1	Fused Silica	230-2500nm	Two lens system (minimizes spherical aberration).
	-C	0.6	BK7	360-2500nm	Aspheric system for maximum throughput and minimal spherical aberration with a 1 lens system.
	-D	0.7	Fused Silica	230-2500nm	Three lens system, best compensation of spherical aberration. Recommended for high quality collimation.
IO—Imaging Optics Line of Optical Assemblies					
Optic Family	Model	Aperture Ratio (F/#)	Standard Material	Spectral Range	Description
IO	-A	Varies	Fused Silica	230-2500nm	Single planoconvex spherical lens.
	-B	Varies	Fused Silica	230-2500nm	Two lens system (minimizes spherical aberration).
	-C	Varies	BK7	360-2500nm	Aspheric system for maximum throughput and minimal spherical aberration with a 1 lens system.
	-D	Varies	Fused Silica	230-2500nm	Three lens system optimized for best compensation of spherical aberration. Recommended for very high quality imaging.

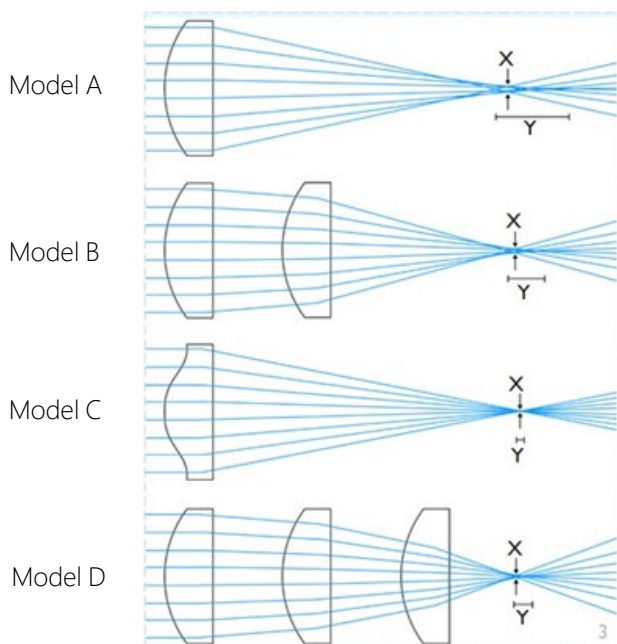

X = Circle of Least Confusion (Spot Size)

Y = Longitudinal Spherical Aberration

Model A - Single Plano-Convex Spherical Lens:

The simplest and least costly option, but with the largest spot size when focused and the poorest quality collimation when collimated.

Model B - Two Lens System:

An intermediate option, with a smaller spot size than Model A when focused and better collimation when collimated.

Model C - Single Aspherical Lens:

The best option for correction of spherical aberration, with the smallest spot size (X) when focused and the best quality collimation when collimated. Only available in BK7 or equivalent glass.

Model D - Three Lens System:

A high-quality option, for a tighter spot size when focused or better quality collimation when collimated than Model A or Model B. It is also available in a wider range of materials than Model C.



Research Grade Xe Arc Lamp 75 - 300 W

CONFIGURATION

2. Configuration—Output Optics

After deciding upon collimating optics or collimating and imaging optics for your application, use the tables below to select the best refractive optics in each field for your application. Additionally, collimating mirror options are available in gold and protected aluminum for applications where reflective optics are preferable (see page 5). If you don't see the right optics for your application in the table below, please contact us! Many further options are available upon request.

Configuration—Output Optics—Collimating

Choose the collimating optics' lens configuration, diameter, and material for your application from the following options. The following is an example order: COL-A-1-FS. This example order contains collimating optics with a single plano-convex lens configuration, 25.4 mm in diameter, and made of fused silica.

Example: COL		-	A	-	1	-	FS
Model Number		Lens Configuration		Diameter		Material Options	
Code	Description	Code	Description	Code	Description	Code	Description
COL	Collimating Optics	A	Single lens	1	25.4mm diameter optics	-UV	UV Fused Silica
		B	Two lens system	2	50.8mm diameter optics	-FS	Fused Silica
		C	Aspheric lens system			-G	BK7 Glass or Equivalent
	c	D	Three lens system			-CF	Calcium Fluoride Glass

Configuration—Output Optics—Imaging

Choose the imaging optics' aperture ratio, lens configuration, diameter, and material for your application from the following options. The following is an example order: IO-3.5-D-1-FS. This example order contains imaging optics with F/3.5, a three-lens system lens configuration, 25.4 mm in diameter, and made of fused silica.

Example: IO		-	3.5	-	D	-	1	-	FS
Model Number		F/# - Aperture Ratio		Lens Configuration		Diameter		Material Options	
Code	Description	Code	Description	Code	Description	Code	Description	Code	Description
IO	Imaging Optics	##	F/# of the optical system	A	Single lens	1	25.4mm diameter optics	-UV	UV Fused Silica
				B	Two lens system	2	50.8mm diameter optics	-FS	Fused Silica
				C	Aspheric lens system			-G	BK7 Glass or Equivalent
				D	Three lens system			-CF	Calcium Fluoride Glass

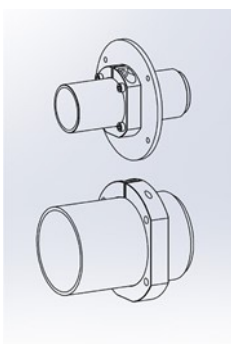

COL 1" diameter optical assembly

COL 2" diameter optical assembly

1. Only available in BK7 or equivalent glass.
2. Ensure that if more than one set of optics are quoted that all optics are compatible—such as ensuring that all optics are the same diameter.
3. Adding optional items will appear on sales orders as custom line items.
4. Single layer MgF₂ antireflection coating with thickness optimized for 550nm is available as an option.



Research Grade Xe Arc Lamp 75 - 300 W

CONFIGURATION

3. Configuration—Output Optics—Material Selection

Different materials can be selected for transmission in different wavelength ranges. Some of the most common options are in the below table for a quick reference of the most useful ranges for each material. If you don't see the right optics for your application in the table below, please contact us! Many further options are available upon request.

Legend	
No Transmission	
Reduced Efficiency Numbers indicate 80% cutoff point)	550 nm*
Most Efficient	

Range	Wavelength (nm)	Photon Energy (eV)	Standard Refractive Optics			
			UVFS	Fused Quartz/Silica	CaF2	BK7
UVC	100-280	4.43-12.4	175 nm	250 nm		
UVB	280-315	3.94-4.43				
UVA	315-400	3.10-3.94				350 nm
VIS	380-700	1.7-3.3				
NIR	700-1400	0.886-1.653				
SWIR	1400-3000	0.413-0.886	2400 nm	2700 nm		2800 nm
MIR	3000-8000	0.155-0.413				
LIR	8000-15000	0.083-0.155			10000 nm	
Far-IR	15000-1000000	0.012-0.083				

3. Configuration—Output Optics—Reflective Optics

MR6 Collimating Mirror Options					
Model	Aperture Ratio (F/#)	Clear Aperture	Reflective Surface	Spectral Range	Description
MR64	4	25 mm	Protected Aluminum	400nm-20µm	25mm diameter F/4 off-axis parabolic mirror with protected aluminum coating on a kinematic adjustable mount.
MR64-G	4	25 mm	Gold	360nm—Far IR	Gold-coated 25mm diameter F/4 off-axis parabolic mirror on a kinematic adjustable mount.
MR62	2	50 mm	Protected Aluminum	400nm-20µm	50mm diameter F/2 off-axis parabolic mirror with protected aluminum coating on a kinematic adjustable mount.
MR62-G	2	50 mm	Gold	360nm—Far IR	Gold-coated 50mm diameter F/2 off-axis parabolic mirror on a kinematic adjustable mount.

MR64 Collimating Mirror in Housing.

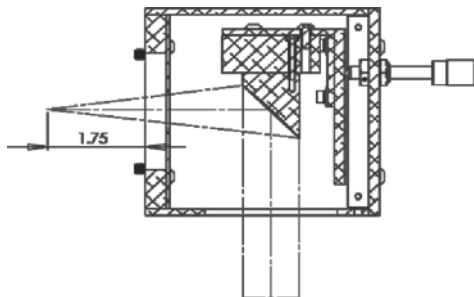

Sciencetech's family of MR6 collimating mirror options are off-axis parabolic mirrors mounted in a housing that can be attached to any LH series lamp housing with the OAP mounting accessory. The MR6 housing includes a three point adjustable kinematic mount with fine pitch threaded screws to optimize alignment of the output optics with the arc lamp.

Research Grade Xe Arc Lamp 75 - 300 W

CONFIGURATION

2. Configuration—Output Optics—Application Configurations

To use Sciencetech LH-series lamp housings with one of Sciencetech's monochromators, the light first needs to be collimated from the lamp house, then coupled into the monochromator by F matching the imaging optics to the monochromator. See the table below for collimating and imaging optics for coupling the LH series arc lamp sources with some of Sciencetech's popular monochromators.

Monochromator Model	Monochromator F/#	Collimating Optics	Imaging Optics
9055F	2.5	COL-A-1-FS	IO-2.5-D-1-FS
9010F	2.6	COL-A-1-FS	IO-2.6-D-1-FS
9030	3.2	COL-A-1-FS	IO-3.2-D-1-FS
9072/9055	3.5	COL-A-1-FS	IO-3.5-D-1-FS
9040	4	COL-A-1-FS	IO-4.0-D-1-FS
9040	5.2	COL-A-1-FS	IO-5.2-D-1-FS
9057F	5.9	COL-A-1-FS	IO-5.9-D-1-FS
9040	6.9	COL-A-1-FS	IO-6.9-D-1-FS
9490	7.4	COL-A-1-FS	IO-7.4-D-1-FS
9057	8	COL-A-1-FS	IO-8.0-D-1-FS
9490	9.7	COL-A-1-FS	IO-9.7-D-1-FS
9490	12	COL-A-1-FS	IO-12.0-D-1-FS
9150	13	COL-A-1-FS	IO-13.0-D-1-FS

EXAMPLE ORDER, 300W TUNABLE LIGHT SOURCE:

LH-S-300X (101-9001)
 XE300 (650-0050)
 601-300 (150-9100)
 COL-A-1-FS (110-9001)
 IO-3.5-D-1-FS (110-XXXX)

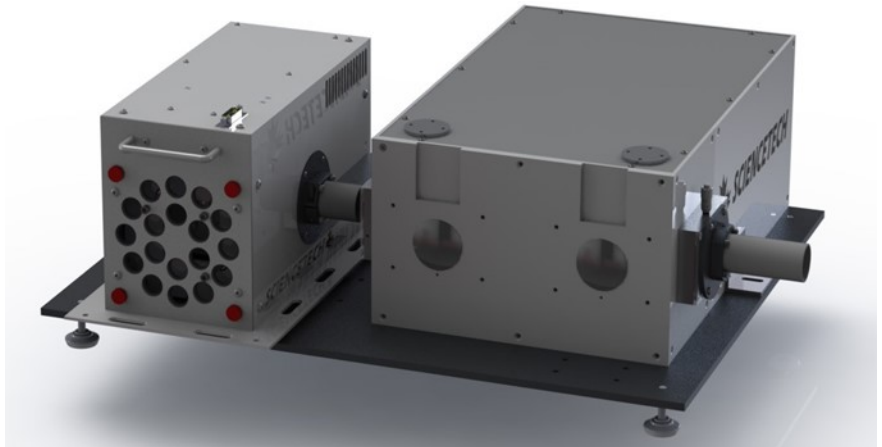

Sciencetech's LH series lamp house configured for a 300W Xe arc lamp, 300W ozone-free Xe arc lamp, compatible 300W Xe arc lamp touchscreen power supply, collimating 25.4 mm diameter fused silica optics, with fused silica imaging optics f-matched to Sciencetech's 9055.

Research Grade Xe Arc Lamp 75 - 300 W

LAMP SELECTION

Step 3
Select
Lamp

Xenon arc lamps need to be included as a separate line items on your order. The information below should be used to help select the proper arc lamp for your lamp house configuration and application!

For more information regarding bulb selection, please contact your Sciencetech technical representative.

Lamp Housing	Compatible Bulb Model	Bulb Wattage	Spectral Range	Ozone Producing
-300X	XE300	300W	250-2500 nm	NO
-300X	XE300-UV	300W	200-2500 nm	YES
-150X	XE150	150W	250-2500 nm	NO
-150X	XE150-UV	150W	200-2500 nm	YES
-100X	XE100	100W	250-2500 nm	NO
-075X	XE075	75W	250-2500 nm	NO

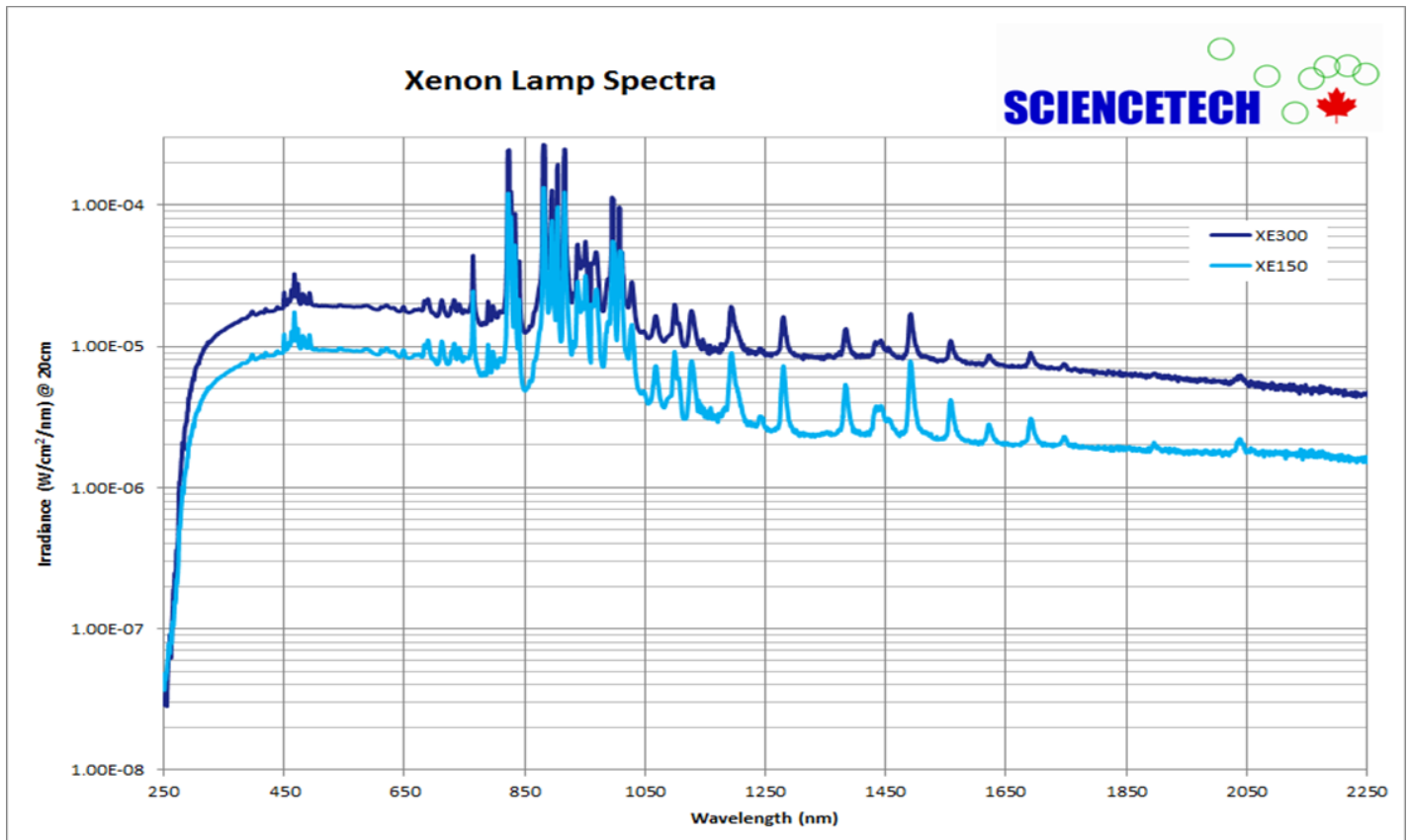

Research Grade Xe Arc Lamp 75 - 300 W

POWER SUPPLY

Step 4
Select Power Supply

Sciencetech's 601- series power supplies are the compatible power supplies for use with Sciencetech's LH series lamp houses. For ordering, ensure that your power supply model matches your system's arc lamp wattage.



Standard features included with Sciencetech's 601-series power supplies:

- Touchscreen interface
- Shutter and exposure control (if electronic shutter is supplied*)
- Single connection for lamp power, cooling, and communication
- Lamp starts and timer log Fan cooling safety interlock
- RS232 computer control software GUI

*high speed shutters require a separate controller

Bulb Type	Power Supply Model
-300X	601-300
-150X	601-150
-100X	601-100
-075X	601-075

LAMP ON	LAMP OFF		21	87.0
		FANS On		88.0
0.0	V	FANS Off		SET
0.0	I	FANS OFF		
0.00	LOG			SHUTTER

Optional Upgrades:

- Temperature monitor
- Optical feedback
- Remote lamp status monitoring
- Auto lamp starting

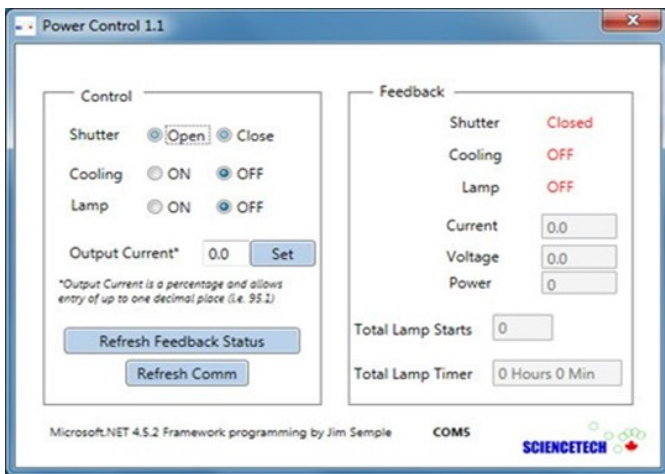

Research Grade Xe Arc Lamp 75 - 300 W

ACCESSORIES

Sciencetech carries many accessories for your light source housing, such as filter boxes for use with Sciencetech's variety of spectral filters, or a downward facing stand. The table below lists Sciencetech's accessories that are compatible with the LH series housing, so you can tailor your Sciencetech system to your application.

	Model	SKU	Description
Filter Boxes	FH2-1	100-8010	One position filter box for 2" (50 mm) filters—uncooled
	FH1-1	100-8011	One position filter box for 1" (25 mm) filters—uncooled
	FH3-1	100-8012	One position filter box for 3" (75 mm) filters—uncooled
	FH1-2	100-8013	Two position filter box for 1" (25 mm) filters—uncooled
	FH3-2	100-8014	Two position filter box for 3" (75 mm) filters—uncooled
Variable Focus Assemblies	VF2	100-8046	Variable focus optical assembly, 2" diameter BK7 optics
	VF2-UV	100-8047	Variable focus optical assembly, 2" diameter fused silica optics
Beam Turners	CTBT-2	160-9005	Beam turning assembly for LH series light sources
Stands	LH-DFS	100-8015	Downward facing stand for LH series light sources
Fiber Couplings	FBC-1	100-8028	Fiber bundle coupler, non SMA, 1"
	FBC-2	100-8029	Fiber bundle coupler, non SMA, 2"
	FBC-SMA-2	100-8030	SMA fiber coupler, 2" flange
	FBC-SMA-1	100-8031	SMA fiber coupler, 1" flange
Shutters	MS-2	160-8040	Manual Shutter for 2" Output Optics
	SH-HS	165-8033	High speed shutter for LH series light sources and SF/SLB solar simulators



LH-S-300X with FH2-1

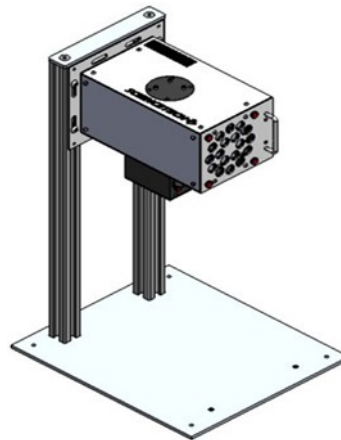

LH-DFS



For information on spectral filtering please see Sciencetech's Bandpass Filters brochure or contact your Sciencetech technical sales representative

Research Grade Xe Arc Lamp 75 - 300 W

DIMENSIONS

Overall H x W x L	170 x 182.9 x 322.6 mm
Weight	5 kg
Optical Height	68.6 mm or 80-100 mm

Mounting Options 1/4-20 leveling feet—M6-M8 through holes—76.2 mm spacing

All dimensions are in millimeters unless otherwise stated.

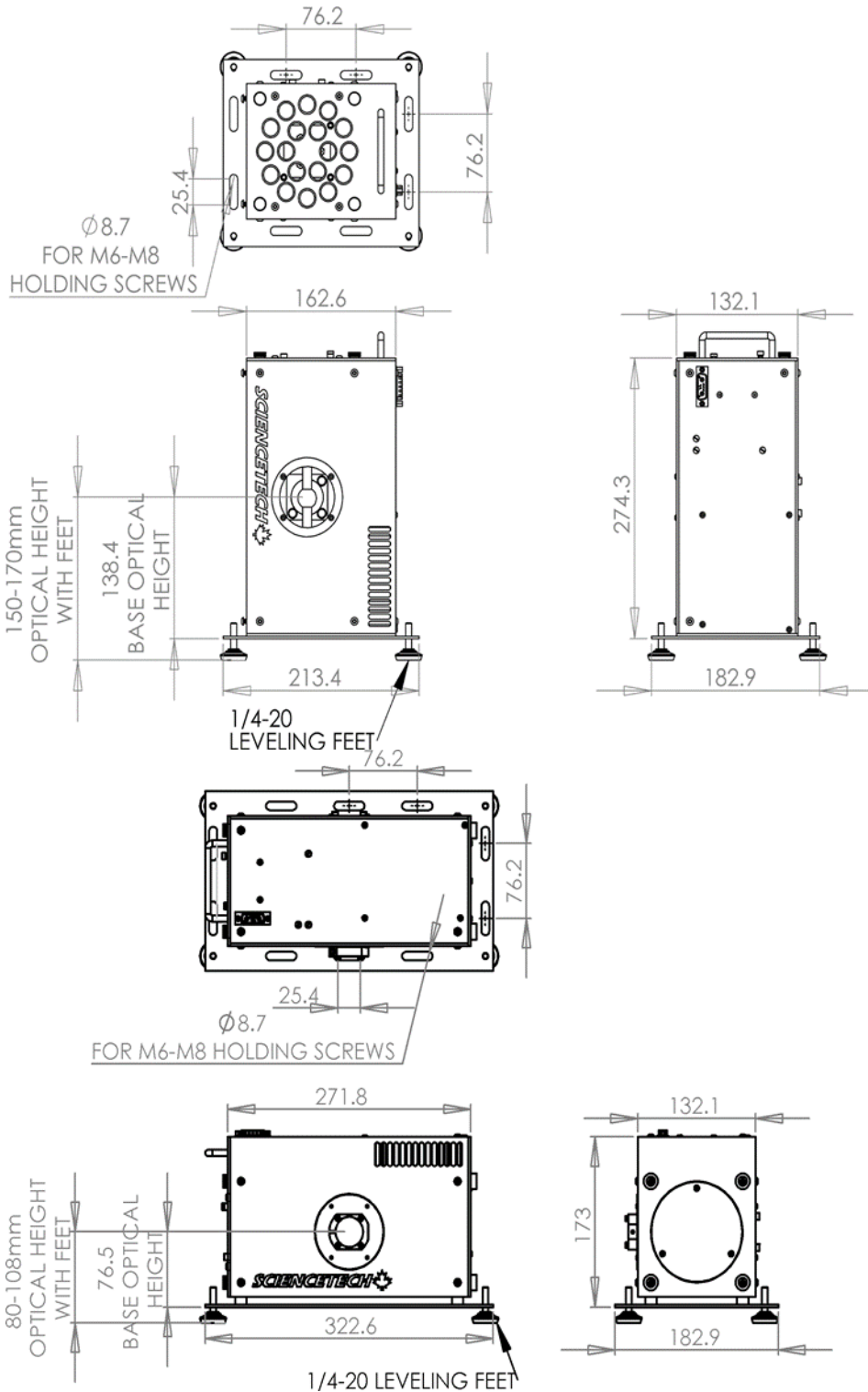

Research Grade Xe Arc Lamp 75 - 300 W

ORDERING INFO

7. Ordering Information

Model	SKU	Description
LH-S-300X	101-9001	LH- series lamp house with spherical back reflector for 300W xenon arc lamps.
LH-S-150X	101-9002	LH- series lamp house with spherical back reflector for 150W xenon arc lamps.
LH-S-100X	101-9003	LH- series lamp house with spherical back reflector for 100W xenon arc lamps.
LH-S-075X	101-9004	LH- series lamp house with spherical back reflector for 75W xenon arc lamps.
LH-E-300X	101-9005	LH- series lamp house with elliptical back reflector for 300W xenon arc lamps.
LH-E-150X	101-9006	LH- series lamp house with elliptical back reflector for 150W xenon arc lamps.
LH-E-100X	101-9007	LH- series lamp house with elliptical back reflector for 100W xenon arc lamps.
LH-E-075X	101-9008	LH- series lamp house with elliptical back reflector for 75W xenon arc lamps.
601-300	150-9100	Power supply for LH- series housing and 300W xenon arc lamp.
601-150	150-9101	Power supply for LH- series housing and 150W xenon arc lamp.
601-100	150-9102	Power supply for LH- series housing and 100W xenon arc lamp.
601-075	150-9103	Power supply for LH- series housing and 75W xenon arc lamp.
XE300	650-0050	300W xenon arc lamp, non-ozone producing.
XE150	650-0091	150W xenon arc lamp, non-ozone producing.
XE150-UV	650-0084	150W xenon arc lamp, ozone producing.
XE100	650-0028	100W xenon arc lamp, non-ozone producing.
XE075	650-0007	75W xenon arc lamp, non-ozone producing.
601-CABLE	150-7007	Replacement power supply cable for 601- series power supply and LH- series housing.

8. Light Source Packages

Product Code	Description of Research Grade Arc Lamp Source	Collimated or Focused	Power (W)	Aperture Ratio (F/#)	Lens Type	Clear Aperture (mm)	Material
101-9109	150 W Collimated Research Grade Arc Lamp Source, 1 inch, F/1.5, Single Lens, Fused Silica, O ₃ -free	Collimated	150	1.5	A	25.4	FS
101-9112	150 W Collimated Research Grade Arc Lamp Source, 2 inch, F/1.5, Single Lens, Fused Silica, O ₃ -free	Collimated	150	1.5	A	50.8	FS
101-9118	300 W Collimated Research Grade Arc Lamp Source, 1 inch, F/1.5, Single Lens, Fused Silica, O ₃ -free	Collimated	300	1.5	A	25.4	FS
101-9124	300 W Collimated Research Grade Arc Lamp Source, 2 inch, F/1.5, Single Lens, Fused Silica, O ₃ -free	Collimated	300	1.5	A	50.8	FS
101-9131	300 W Focused Research Grade Arc Lamp Source, 2 inch, F/4.5, O ₃ -free	Focused	300	4.5	-	50.8	-

Our convenient light source packages come with the lamp housing, optics package, power supply, and bulb—everything you need to start using your research-grade light source. Many other options are available, so if these packages do not perfectly meet your needs, contact a Sciencetech Technical Specialist for more options.